

Signature® Flow Meter Pocket Guide

This pocket guide is not intended to replace the instruction manual. Read the instruction manual thoroughly before operating the equipment.

COPYRIGHT © 2013 by
Teledyne Isco
4700 Superior St.,
Lincoln, Nebraska, U.S.A. 68504
Phone: (402) 464-0231
Toll Free: (800) 228-4373
FAX: (402) 465-3022

Part #69-4303-093
Released: January 2013

Before installing, operating, or maintaining this equipment, you should read the full user manual. While specific hazards may vary by location and application, it is still helpful to read this safety section, as well as the general safety information contained in the full instruction manual.

If you have any questions regarding the equipment or its installation, contact Teledyne Isco or one of its representatives for assistance. This manual applies Hazard Severity Levels to the safety alerts. Two levels used in this manual are described in the sample alerts below.



CAUTION

Cautions identify a potential hazard, which if not avoided, may result in minor or moderate injury. This category can also warn you of unsafe practices, or conditions that may cause property damage.



WARNING

Warnings identify a potentially hazardous condition, which if not avoided, could result in death or serious injury.

Signature® Flow Meter Pocket Guide

Table of Contents

1. Quick Start

1.1 Overview	1-1
1.2 Visual Guides	1-2
1.2.1 TIENet Wiring	1-2
1.2.2 Keypad Functions	1-3
1.2.3 Hardware Setup	1-5
1.2.4 Configuration Options	1-5
1.2.5 Administration	1-5

2. Setup and Programming

2.1 User Interface	2-1
2.2 Home Screen	2-2
2.3 Shortcuts	2-3
2.3.1 Adjust Level	2-3
2.3.2 Adjust Velocity	2-3
2.3.3 Purge (Bubbler Only)	2-3
2.3.4 Histogram	2-4
2.3.5 Report View	2-4
2.4 Programming	2-4
2.4.1 Off-Screen Content	2-5
2.4.2 Character Grid	2-5
2.4.3 Pull Down Menus	2-6
2.5 Main Menu	2-7
2.6 Hardware Setup	2-8
2.7 Configuration Options	2-9
2.7.1 Site Setup	2-10
2.7.2 Measurement Setup	2-10
2.7.3 Adjust	2-15

2.8 Administration	2-16
2.9 USB Options	2-17

3. Installation

3.1 Accessing the Interior	3-1
3.2 Case Bottom Cable Entries	3-5
3.3 Connecting TIENet Devices	3-6
3.4 Power	3-10
3.4.1 Connecting Mains Power ...	3-11
3.5 Setting the Level	3-13

4. Maintenance and Troubleshooting

4.1 Cleaning	4-1
4.2 Desiccant	4-1
4.2.1 Internal Desiccator	4-2
4.2.2 External Desiccator	4-3
4.2.3 Renewing loose desiccant ...	4-6
4.3 Troubleshooting	4-7
4.3.1 Signature Flow Meter	4-8
4.3.2 TIENet 300 Connector Case	4-13
4.3.3 TIENet 301 pH/Temp	4-15
4.3.4 TIENet 306 Sampler Interface ..	4-17
4.3.5 TIENet 308 Analog Output .	4-18
4.3.6 TIENet 310 USLS	4-22
4.3.7 TIENet 330 Bubbler	4-25
4.4 Service and Repair	4-27
4.4.1 Contact Teledyne Isco	4-27

Signature® Flow Meter Pocket Guide

Section 1 Quick Start

1.1 Overview

The Signature Flow Meter is designed for open channel flow monitoring applications using any combination of flow and parameter measurement technologies and sampling, depending on what is required at the monitoring site.

Measurement devices for flow and water quality can be connected to the same Signature and run simultaneously with TIENet™ connectivity (up to 9 TIENet devices). The flow meter can also communicate with an optional Teledyne Isco wastewater sampler.

For complete information about Signature and TIENet installation, operation, and options, refer to the full-length user manuals for the Signature meter and TIENet devices.

1.2 Visual Guides

This section provides a quick visual guide for TIENet wiring, keypad functions, and the top programming menus.

1.2.1 TIENet Wiring

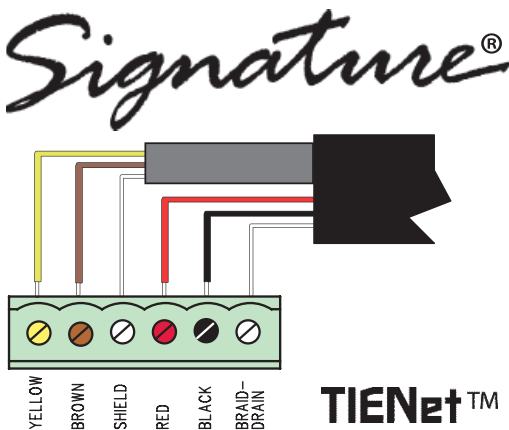

1.2.2 Keypad Functions

Numerical:



- Enter values
- Type characters

Arrows:



- Navigate up, down, left, right

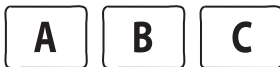

Soft Keys:



- Current displayed function
- **Back** = Return to last menu
- **Next** = Confirm & advance to next step

Enter:



- Open list
- Confirm selection
- Activate field
-  = Pull down list available
-  = Character grid available

Delete/Exit:



- Clear last entry
- Exit list
- Close window

Home:



- Return to Home Screen from anywhere

1.2.3 Hardware Setup

1. TIENet Devices
2. SDI-12 Setup
3. Modbus In
4. Modbus Out
5. Modem

1.2.4 Configuration Options

1. **Site:** Clock, Name, Display, Units
2. **Measurement Setup:** Level, Velocity, Flow, Volume
3. **Adjust:** Level, pH, Velocity
4. Equation / Trigger
5. Data Storage Rate / Data Push
6. Sampler Interface Setup
7. **Outputs:** Alarm, Analog
8. Reset Totalizers
9. Reports / History

1.2.5 Administration

1. Language
2. Set New Passcode
3. Update Firmware
4. Sensor Diagnostics
5. System Information
6. License Information
7. Gather Fault Data
8. Restore Defaults

Signature® Flow Meter Pocket Guide

Section 2 Setup and Programming

2.1 User Interface

The Signature Flow Meter can be set up, programmed, and interrogated directly through the keypad and display screen, or remotely using a computer equipped with Teledyne Isco's Flowlink® software version 5.1.510 or later, with either a USB cable or optional modem.

The Signature Flow Meter has its own browser, accessed via Flowlink, that mirrors the physical keypad and display.

Complete flow meter connection, setup, and programming instructions are provided in the Signature User Manual.

Complete Flowlink software instructions are provided in the context-sensitive Flowlink Help menus and software user manual.

2.2 Home Screen

The home screen, or run screen, is displayed when the flow meter is in normal operating mode. This screen shows the current parameter readings and system status or alarm conditions.

A scroll bar on the right of the screen indicates there are more parameters off-screen that can be viewed by scrolling up or down.

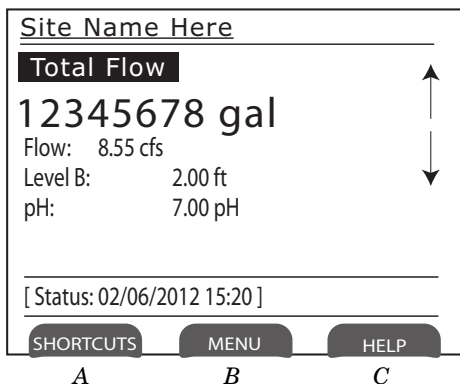



Figure 2-1 Home screen (normal operating mode)

2.3 Shortcuts

The Shortcuts menu provides quicker access to most commonly used commands, such as level adjustment or viewing data recorded over a period of time. Not all menu items described in this section will necessarily appear in your Shortcuts menu. The selections available in the Shortcuts menu are determined by what connected devices have been detected by the Signature flow meter. To access your shortcuts, press SHORTCUTS ().

2.3.1 Adjust Level

To set a new level, enter the value in the field next to Level, and select Adjust. To update the current reading, select Update.

2.3.2 Adjust Velocity

This selection will open the velocity grid with current readings and laser controls for the TIENet LaserFlow velocity sensor. For complete information about this device, refer to the TIENet 360 LaserFlow user manual.

2.3.3 Purge (Bubbler Only)

The Signature Bubbler flow meter allows you to manually purge the bubble line if an obstruction is suspected.

2.3.4 Histogram

The histogram displays the measurements taken of up to three selected parameters in graphical format, beginning at your selected date/time, and spanning one to 48 hours. Enter a value in the Threshold field for a reference line. The measurements available for graphing are determined by what measurements are set up for data storage.

2.3.5 Report View

Reporting is set up from the Configure Options menu. **Summary** displays summaries of data measurements (i.e., Min/Max/Avg). **History** tracks user and meter events. **Program** tracks changes made to the flow meter's program configuration.

2.4 Programming

To access the setup/program menus, press

MENU ().

When you press MENU, the four top menu options appear:

Hardware Setup detects all devices connected to the flow meter, establishes proper communication with them, and allows configuration of each device.

Configuration Options sets up the measurement site and program parameters.

Administration dictates operating preferences and perform general housekeeping tasks.

Home returns to the home screen.

Additionally,

USB Options appears when a flash drive is connected to the USB port in the lower left corner of the control panel.

The program menus consist of steps and substeps. During programming, available subordinate menu content and steps will be determined by what you have previously entered, and what optional equipment is connected to the Signature flow meter.

2.4.1 Off-Screen Content



An arrow in the lower right corner of the flow meter's screen indicates that there is additional content on this screen in the direction the arrow is pointing. Use the arrow keys to access this content.

2.4.2 Character Grid

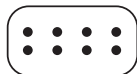

A small grid icon in the lower right corner of the flow meter's screen indicates that the character grid is available.

Whenever you need to enter characters, such as letters, numbers, or punctuation, press Enter to display the character grid (Figure 2-2).

Use the arrow keys to navigate to the desired character and press Enter to select. When you are finished editing, select DONE and press Enter.

Isco Test Site														
Done		Cancel												
A	B	C	D	E	F	G	H	I	J	K	L	M	N	▲
O	P	Q	R	S	T	U	V	W	X	Y	Z	a	b	
c	d	e	f	g	h	i	j	k	l	m	n	o	p	
q	r	s	t	u	v	w	x	y	z	/	:	!		
@	#	\$	%	^	&	*	()	-	_	+	=	<	
>	?	,	.											▼

Figure 2-2 Character grid

2.4.3 Pull Down Menus



Fields with a pull down arrow next to them (see example at left) indicate a pull down list. Use the arrow keys to navigate between fields on the screen; when you highlight a pull down field, press Enter to display the items on the list. Then use the arrow keys and Enter to select from the list.

2.5 Main Menu

Menu

1. Hardware Setup
2. Configure Options
3. Administration
4. Home

Hardware Setup

1. Smart Sensor Setup (TIENet)
2. SDI - 12 Setup
3. MODBUS Input Setup
4. MODBUS Output Setup
5. Modem Setup

Configure Options

1. Site Setup
2. Measurement Setup
3. Adjust
4. Equation/Trigger Setup
5. Data Storage/Push Setup
6. SAMPLER SETUP
7. Outputs/Alarms Setup
8. Reset Totalizers
9. Report/History Setup

Administration Options

1. Language Options
2. Set New Password
3. Update Firmware
4. Sensor Diagnostics
5. Display Signature Information
6. Display License Information
7. Gather Fault Data
8. Restore Factory Defaults

HOME
(Returns to home screen)

Figure 2-3 Menu Tree: Main menu

2.6 Hardware Setup

From the Hardware Setup menus, the flow meter detects and configures all connected devices.

- Hardware Setup
1. Smart Sensor Setup (TI ENet)
 2. SDI -12 Setup
 3. MODBUS Input Setup
 4. MODBUS Output Setup
 5. Modem Setup

Smart Sensor Setup (TI ENet)

- View system devices
- Configure measurements
- Perform scan

All TIENet devices detected by the most recent scan will be listed under Smart Sensor Setup, by Serial Number and Device Type.

MODBUS Output Setup

- Enter MODBUS address from 2 to 247.
- Configure communication protocol

For Modbus output register information, refer to Appendix C in the Signature User Manual

SDI -12 Setup

- Scan for connected sondes
- Add/Remove
- Configure/Manual config

Modem Setup

Screen content determined by type of modem installed. Refer to Cellular Modem Configuration in the Signature User Manual.

Figure 2-4 Menu Tree: Hardware Setup

2.7 Configuration Options

The Configure Options menu is used for setting up the measurement site and setting the program parameters.

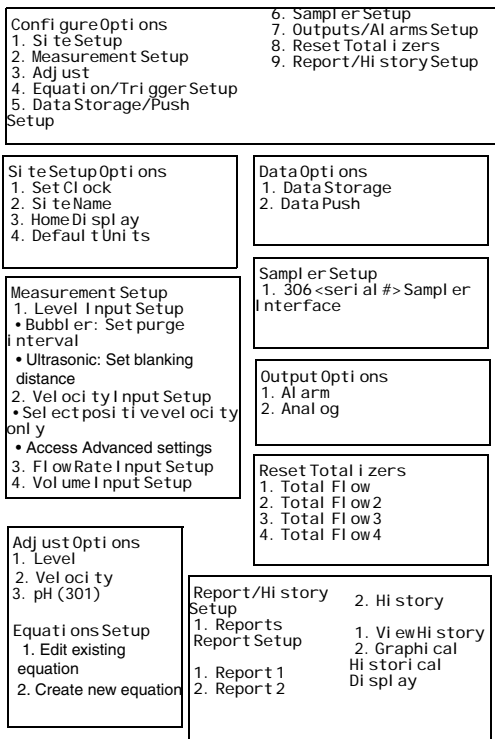

Figure 2-5 Menu Tree: Configure

2.7.1 Site Setup

The Site Setup menu sets some basic operating characteristics specific to the site.

Set Clock

Enter Year, Month, Day, Hour, Minute.

Site Name

Press Enter to display the character grid. Select one character at a time to create the desired site name.

Home Display

The Home Display determines how current measurement data is displayed on the Home screen.

From the Measurements Setup screen, select all measurement parameters to be displayed. The parameters available in the pull down menus will be determined by what devices are connected to the Signature meter.

Default Units

To set units of measure for each parameter, first select the parameter from the menu list. The available units of measure that appear will be determined by the parameter you have selected. Under Units, highlight the units of measure and press NEXT. When finished, press NEXT again to save and exit.

2.7.2 Measurement Setup

This menu is for setting up the level measurement (Level Input Setup), flow conversion (Flow Input Setup), and flow volume

totalizer(s) (Volume Input Setup). Menu items that appear are dependent on what equipment is connected to the Signature flow meter.

Level Input Setup

Under Level Setup, select the level input. Usually there will only be one listed, unless your system is using more than one level measurement device.

For the TIENet 310 ultrasonic sensor, the minimum blanking distance refers to the maximum water level, and the maximum blanking distance refers to zero water level in the channel. For detailed instructions about 310 setup, refer to the TIENet 310 Installation and Operation Guide.

Flow Rate Input Setup

Measurement settings and flow conversion are programmed for the flow rate(s) from this menu (refer to Figure 2-6 on the following page). If more than one flow rate data set is being calculated, these settings are programmed separately for each one.

1. Select the flow rate to set up.
2. For level-to-flow conversions, from Measurement Settings, select the Level Input to be used in the flow calculation and the Measurement Rate (interval). Enter the name for this flow rate.
3. Select the flow conversion type to be used (Weir, Flume, Metering Inserts, Manning Formula, Area Velocity, Equation, or Data Points); then set up the conversion.

 **Note**

Additional information about flow conversions can be found in the *Isco Flow Measurement Handbook* included with the Signature Flow Meter.

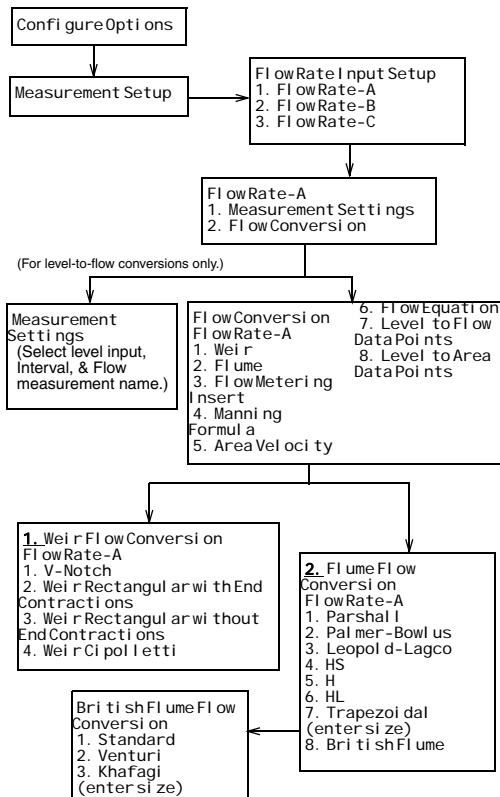

Figure 2-6 Menu Tree: Flow rate input (1)

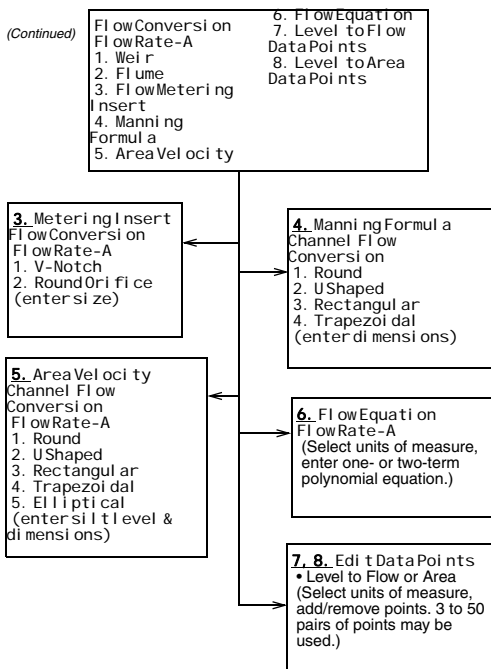

Figure 2-7 Menu Tree: Flow rate input (2)

Volume Input Setup

You can set up one to four Total Flow measurements. Select the flow rate(s) used for total volume, the totalizing method (Net, Positive, or Negative), and the interval at which the total flow will be updated (between 30 seconds and 24 hours).

From the Resolution pull down menu, select the degree of resolution required for your total flow (lower = fewer digits to right of decimal; higher = more digits to right of decimal).

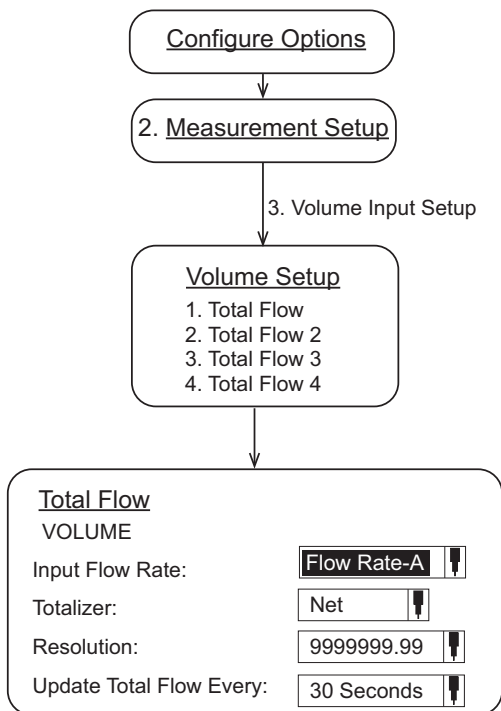

Figure 2-8 Menu Tree: Volume Input Setup (total flow)

2.7.3 Adjust

Adjust levels and/or velocity measurement, and/or calibrate measurement values for other connected TIENet devices.

Note

For detailed instructions on calibration of a connected TIENet 301 pH device through this menu selection, refer to the 301 user manual.

Note

For detailed instructions on laser velocity measurement setup through this menu selection, refer to the LaserFlow (360) user manual.

2.8 Administration

Administrative settings dictate operating preferences and perform general housekeeping tasks.

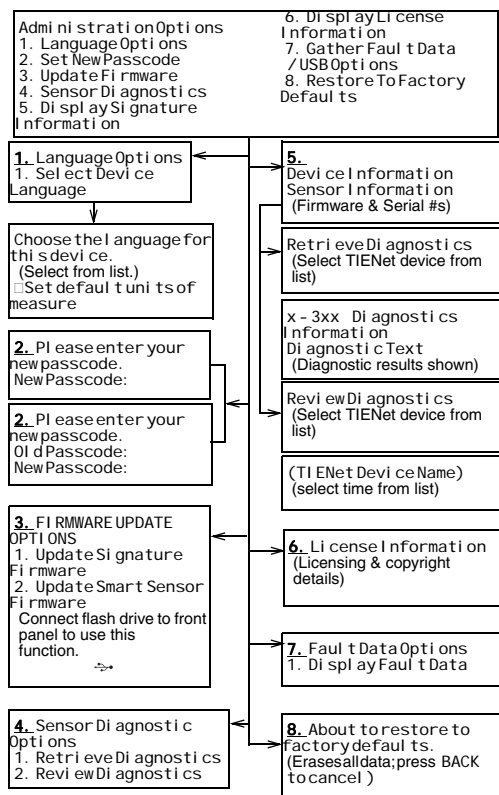

Figure 2-9 Menu Tree: Administration

2.9 USB Options

The USB Options menu will only appear when you connect a flash drive to the USB port on the front panel of the Signature.

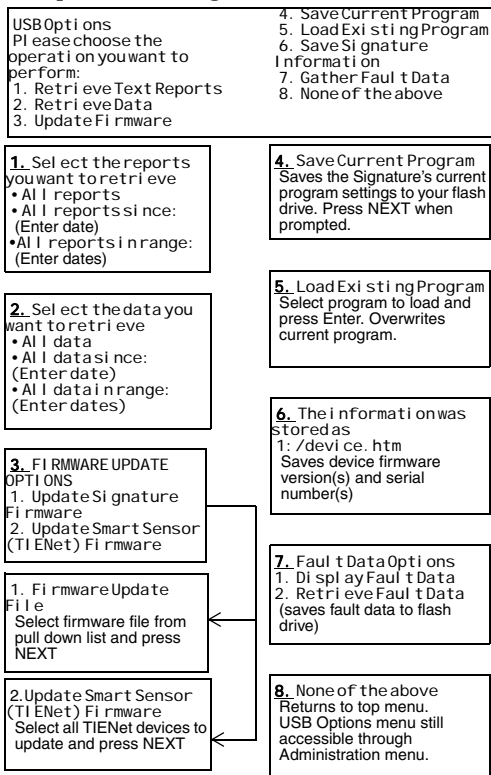

Figure 2-10 Menu Tree: USB Options

Signature® Flow Meter Pocket Guide

Section 3 Installation

This section contains physical preparation procedures and mounting methods for the Signature Flow Meter and associated Teledyne Isco equipment.



WARNING

The installation and use of this product may expose you to hazardous working conditions that can cause serious or fatal injury. Take all necessary precautions before entering a worksite. Install and operate this product in accordance with all applicable safety and health regulations and local ordinances.

3.1 Accessing the Interior

External device cables and mains line cord are passed, usually via conduit or cord-grip fittings, through the port holes in the bottom of the case and wired directly to the connector case.

Tinning unterminated wires prior to installation is recommended.

Tools Required:

Small flat screwdriver (3.5mm)

#2 Phillips screwdriver

Channel locks

Soldering iron (for tinning wires)



Before opening the case, first ensure that mains power is disconnected from the unit.



Before opening the case, disconnect the optional battery backup power, if used.

 **Note**

Before restoring mains power, ensure that the flow meter's USB connector does not have a cable attached.

Open the door to access the two large screws holding the front panel on the connector case. Remove the two screws.

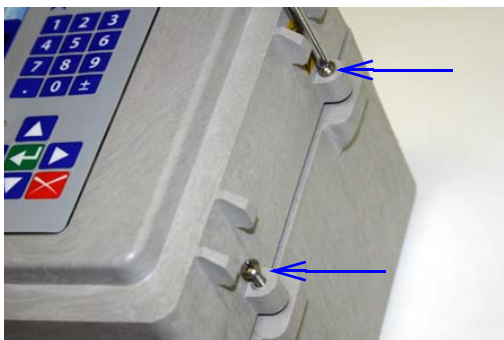
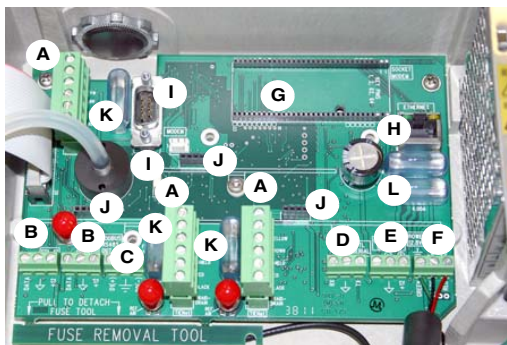

Figure 3-1 Open door and front panel to access interior

Open the front panel to access the connector case. Connectors on the board are identified in Figure 3-2.



A	External TIENet Devices/ Modbus In D1 = Yellow (+) D0 = Brown (-)	G	Ethernet Modem
B	SDI-12 Input	H	Ethernet Port
C	Modbus RS485 Out	I	Cellular Modem (power & serial)
D	TTL Serial	J	4-20mA Output
E	Battery Backup	K	Fuse "T" 3.15A
F	12.8 VDC	L	Fuse "T" 4.00A

Figure 3-2 Connector case, connectors, and fuses

✓ Note

The three TIENet terminal strips (A) are interchangeable; any of the devices can be connected at any of the three locations.

3.2 Case Bottom Cable Entries

The connections made through the cable entries depend on the application, but their most common uses, in accordance with the connector case layout, are depicted below.

All optional cable entries must use appropriate ID conduit connections or cord-grip fittings to retain the IP68 rating. If you are using non-TIENet or non-Signature cables, you must supply the appropriate ID conduit connections or cord-grip fittings.

**CAUTION**

If you are using conduit instead of the cord-grip fitting, the conduit and wires must be sealed to prevent harmful gases and moisture from entering the Signature enclosure. Failure to seal conduit could reduce equipment life.

3.3 Connecting TIENet Devices

The optional external TIENet devices compatible with the Signature flow meter all connect in the same manner. Multiple TIENet devices can be connected simultaneously to the same Signature Flow Meter.

✓ Note

The steps that follow include instructions for installing cord-grip fittings. Some applications will use user-supplied $\frac{3}{4}$ " ID conduit for cable routing.

1. Remove one of the 6-position plug-in terminal strip connectors from the connector case.

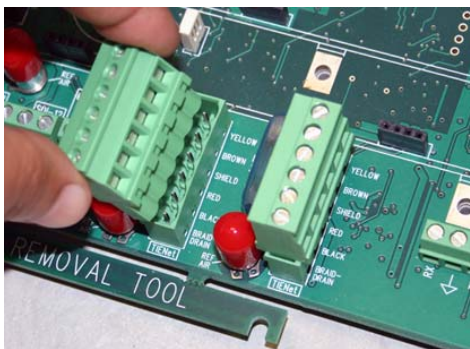

Figure 3-3 TIENet Device terminal strips

2. If using a cord-grip fitting, install the cable nut in the appropriate opening on the bottom of the Signature enclosure, securing

it to the wall with the lock nut (concave side facing wall).

3. Feed the TIENet device cable end through the sealing nut and seal, and through the cable nut. Lightly tighten the sealing nut, just enough to hold the cable in place while installing the connector.

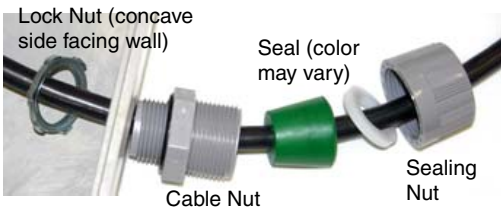

Figure 3-4 Installing TIENet cable with a cord-grip fitting

4. Attach the wire ends to the terminal strip as shown in Figure 3-5, then press the terminal strip back down into its socket on the case board, as shown in Figure 3-6, taking care not to strain any wire connections. Gently tug each wire when finished, to verify secure connection to the screw terminals.

Note

The SHIELD wire is the bare drain emerging from the foil shield around the YELLOW and BROWN wires. The BRAID-DRAIN wire is the bare drain emerging from the surrounding braided shield inside the cable jacket. It is not necessary to prevent the two braids from coming into contact with each other.

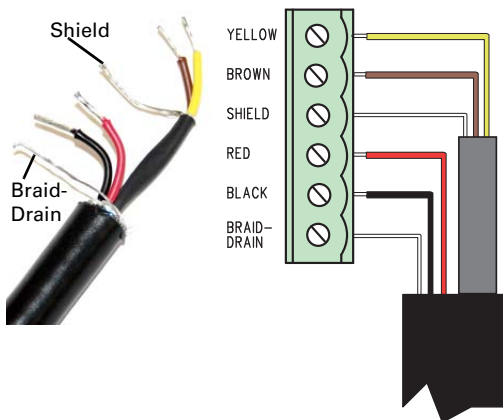

Figure 3-5 TIENet Device terminal connections

D1	YELLOW
D0	BROWN
Shield	SHIELD
VP	RED
Common	BLACK
Chassis	BRAID DRAIN

All optional cable entries must use appropriate ID conduit connections or cord-grip fittings to retain the IP68 rating. If you are using non-TIENet or non-Signature cables, you must supply the appropriate ID conduit connections or cord-grip fittings.



Figure 3-6 Attach wire terminal strip to connector case socket

a. **Systems using the TIENet 350 Area Velocity Sensor Only:**

Insert the reference tubing into the REF AIR port on the case board, pushing it down inside the silicon tubing. Be **careful not to kink the reference tubing.**

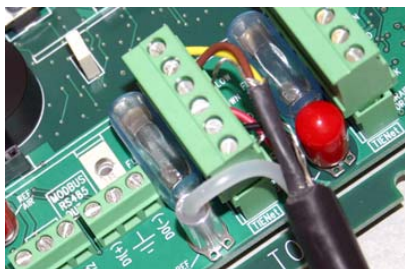

Figure 3-7 Insert the cable reference tubing into the case board reference port (System w/ TIENet 350)

5. Tighten the cord grip sealing nut.



Figure 3-8 Position and secure the cable

6. Close the front panel and fasten it shut with the two Phillips screws.



CAUTION

If you are using conduit instead of the cord-grip fitting, the conduit must be sealed to prevent harmful gases and moisture from entering the Signature enclosure. Failure to seal conduit could reduce equipment life.

3.4 Power

The Signature is in compliance with North American and International safety standards while the input voltage remains within 100-240VAC (50/60Hz).

AC line wiring to the Signature power supply should use twisted pair cabling for optimal electromagnetic compatibility (EMC) with the surrounding environment.

External current protection between mains power and the flow meter must allow for up to 40A inrush current at power up.

If the instrument has been fitted with a line cord, ensure that its installation is near a mains outlet for easy access to remove power in the event of an emergency.

If the instrument has been hard-wired for power using conduit, ensure that a switch or mains circuit breaker is installed near the instrument for easy access to remove power in the event of an emergency.

3.4.1 Connecting Mains Power

The flow meter comes with the power supply wired to the connector case, and held in place by a screw (Figure 3-9 below).

Mains power is wired into the Signature's internal power supply, normally via a standard three-wire line cord (sold separately or user-supplied).

For complete power supply installation instructions, refer to Section 4 of your user manual.

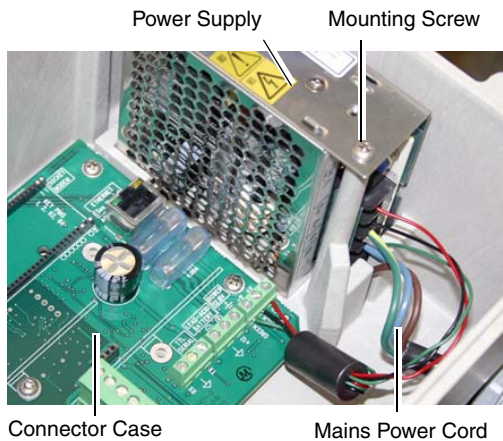

Figure 3-9 Location of power supply

3.5 Setting the Level

Prior to installing the bubble line or sensor in the flow stream, enter a value of zero (0) for level, under Configure > Adjust Options. Highlight “Adjust” and press Enter to confirm. From this screen, you can also update the display to show the current level of the stream.

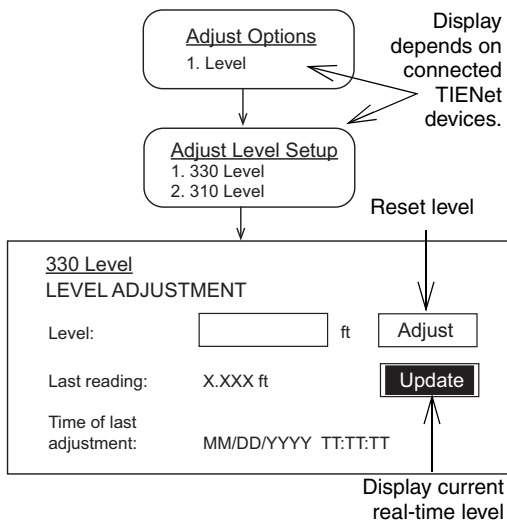

Figure 3-10 Level adjustment

Signature® Flow Meter Pocket Guide

Section 4 Maintenance and Troubleshooting

4.1 Cleaning

Proper care and regular maintenance of the Signature Flow Meter and associated equipment help to maximize performance and ensure continued operation of the system.

The Signature flow meter may be cleaned with water and a mild detergent. For hard to remove stains, isopropyl alcohol may be used. If the instrument is in an isolated area and the case is sealed closed, it may be cleaned using a water hose.

4.2 Desiccant

The inside of the flow meter housing must be kept dry at all times to prevent moisture damage to the internal components. All Signature flow meters have an internal desiccant bag to absorb moisture. Signature flow meters using a 330 bubbler or 350 AV sensor also require an external desiccator.

If increased humidity is indicated by either the humidity reading of the flow meter or the color of the external desiccant, the desiccant must be renewed or replaced before damage occurs.

If this occurs more frequently than expected, inspect the seals of cord-grip fittings and conduit, if used.

4.2.1 Internal Desiccator

Saturated internal desiccant bags must be replaced; unlike the external desiccant, they are not renewable.



DANGER

Before opening the case, first ensure that mains power is disconnected from the unit.



CAUTION

Before opening the case, disconnect the optional battery backup power, if used.

Open the case, as described in Section 3.

The desiccant bag is held in place by a metal bracket. Remove the two screws holding the bracket.



Figure 4-1 Removing the internal desiccant bag

4.2.2 External Desiccator

The desiccator vents the reference port for a pressure transducer, and the air intake port for the bubbler system air pump, keeping the interior of the flow meter case dry.

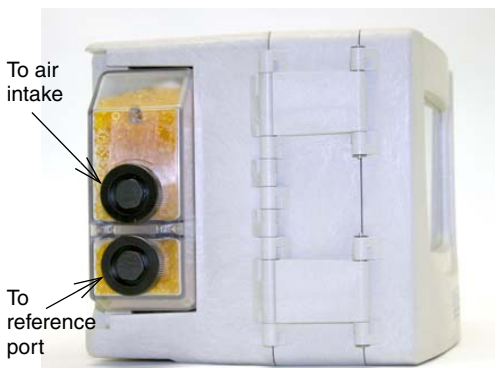

Figure 4-2 External desiccator, installed

When dry, the loose silica gel desiccant inside the chambers is orange or yellow. When the desiccant is saturated with moisture, it turns green or blue, indicating the intake air and reference line are prone to humidity.

Note

Teledyne Isco recommends checking the desiccant at least every 6 months, and changing/renewing the desiccant before the entire compartment has changed color.

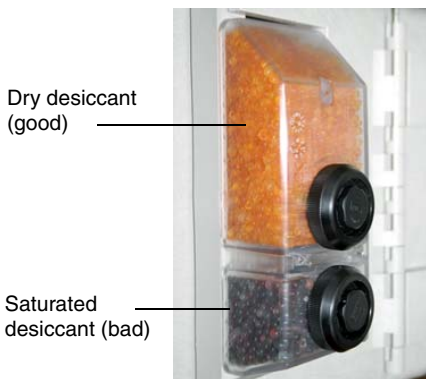

Figure 4-3 Desiccant indicating saturation

The desiccant cartridge is held in place by a spring tab on the side of the flow meter. Press against the front of the cartridge to disengage it from the unit.



Figure 4-4 Removing the external desiccant cartridge

Unscrew the two black caps and carefully pour the desiccant out.

If removal is difficult, screw the caps back in and unscrew again.

Gently knock the caps and the cartridge against a hard surface to free any small particles in the threads, as these can hinder proper sealing and cause wear.

Using a funnel, fill both chambers with dry desiccant, replace the caps, ensuring that they are fully engaged. Press the cartridge back into place on the side of the flow meter.

✓ Note

If this is a new desiccant cartridge, remove the two red protective end caps from the ports before installing a new cartridge.



Figure 4-5 Opening the desiccant cartridge chambers

4.2.3 Renewing loose desiccant

To renew the desiccant, spread it in a single layer on a flat metal tray. Place in a vented, circulating forced air, conventional oven in a well ventilated room, and heat at 100 - 175°C (212 - 350°F) for about three hours, or until the color has returned to orange or yellow.

4.3 Troubleshooting

The tables in the following section provide troubleshooting information to help in determining the causes of problems that may occur with the Signature flow meter or TIENet devices.

The troubleshooting tables cover the flow meter and each TIENet device separately. Note that the 300 TIENet device (Table 4-2 is the internal connector case.

Any time a circuit board is replaced or a sensor disconnected, you **MUST** perform a hardware scan and SDI-12 scan (if connected) before resuming operation.

4.3.1 Signature Flow Meter

Table 4-1 Troubleshooting Signature Flow Meter

Symptom	Cause	Action
Blank Display but audible "beep" when a key is pressed	Contrast is out of adjustment	Adjust the display contrast by repeatedly pressing the up or down arrow while holding down the +/- key.
	Faulty Display	Replace with known good display.

Table 4-1 Troubleshooting Signature Flow Meter (Continued)

Symptom	Cause	Action
Blank Display and no beep when a key is pressed	DC power supply not supplying 12.8 VDC output.	Check for proper AC voltage. If proper AC voltage is present, replace DC power supply.
		Service check: Disconnect the internal power supply wires (Red +/pos, Black –/neg) from the power terminals. Connect an Isco adaptor cable to the power terminals (Black +/pos, White –/neg). Then connect an Isco power supply (Model 913, 914, 923, or 924) to the adaptor cable. If the Signature then functions properly, replace the internal power supply.

Table 4-1 Troubleshooting Signature Flow Meter (Continued)

Symptom	Cause	Action
Blank Display and no beep when a key is pressed	Broken or loose wire from power supply module to the connector case.	Repair connections (Red +/pos, Black -/neg).
	Open Fuse F3	Replace 4A/250V/5X20mm Slo Blo fuse. If the fuse opens again, check for devices that may be shorting the supply, such as a modem or option card.
Nonresettable totalizer does not advance	Programming error - Zero flow rate or asterisk (*)	Check measurement configuration of level, flow rate, and volume input for the Total Flow parameter.

Table 4-1 Troubleshooting Signature Flow Meter (Continued)

Symptom	Cause	Action
Nonresettable totalizer does not advance (continued)	Broken wire connection	Check wire connections for the totalizer on the CPU board.
USB device not recognized - No USB Options screen	Meter was booted up with USB adapter cable connected.	Remove USB cable and reboot the meter
	Meter was booted up with USB to computer cable connected.	

Table 4-1 Troubleshooting Signature Flow Meter (Continued)

Symptom	Cause	Action
USB device not recognized - No USB Options screen (continued)	Flash drive encrypted or defective	Try a different USB Flash drive
	Adaptor cable defective	Replace USB Adaptor Cable 480-2946-02
Cannot update software / Read flash drive	The necessary files are not on the flash drive.	Load the firmware from our website onto the flash drive, into a folder named BIN-FILE.

4.3.2 TIENet 300 Connector Case

Table 4-2 Troubleshooting TIENet 300 Connector Case

Symptom	Cause	Action
TIENet or SDI12 devices not appearing on display for configuration	Device has not been scanned.	Perform a hardware scan from Smart Sensor Setup or SDI-12 Setup.
	Device is not wired correctly.	Rewire connector following label on the case circuit board.
	Open Fuse	Check fuse F1, F4, F5. Replace if open. 3.15A Fuse 411-0212-70
	Defective TIENet or SDI12 device.	Substitute a known working device and rescan. If it now works, replace the faulty device.

Table 4-2 Troubleshooting TIENet 300 Connector Case (Continued)

Symptom	Cause	Action
TIENet or SDI12 devices not appearing on display for configuration (continued)	Device not configured for display on the Home Display.	Add the parameters to the Home Display.
	Wired incorrectly.	Repair/rewire per the label on the connector case.

4.3.3 TIENet 301 pH/Temp

Table 4-3 Troubleshooting TIENet 301 pH/Temp

Symptom	Cause	Action
pH Will not calibrate	Probe defective	Replace pH Probe 60-9004-126
	301 module not recognized	Rescan device in Hardware Setup
		Check TIENet wire connections. Follow wiring code silkscreened on circuit board.
	No sensor connected to the 301	Connect pH probe
pH Will not calibrate	TIENet connection fuse open	Replace if open. 3.15A Fuse 411-0212-70

Table 4-3 Troubleshooting TIENet 301 pH/Temp (Continued)

Symptom	Cause	Action
Incorrect pH readings / slow response	Buffers contaminated or wrong buffer used.	Use new/correct pH buffer solution.
	Temperature is not being read.	Replace pH Probe 60-9004-126
	Probe bulb is contaminated	Clean probe and recalibrate. If readings are still incorrect, replace probe.
	Calibrated before reading stabilized.	Recalibrate and allow the readings to stabilize before continuing with calibration.

4.3.4 TIENet 306 Sampler Interface

Table 4-4 Troubleshooting TIENet 306 Sampler Interface

Symptom	Cause	Action
Incorrect pacing interval	Incorrect flow total selected for pacing	Assign the correct sensor to the correct flow rate to the correct total flow. Example: Needed to pace from the 330 bubbler, but programmed to pace from the 310 USLS.
No sampler pacing	Sampler's flow pulse input not working	Connect a different sampler, or test the existing sampler by shorting pins A and C on the sampler's Flow Meter port, while the program is running. The displayed pulse count should count down.

4.3.5 TIENet 308 Analog Output

Table 4-5 Troubleshooting TIENet 308 4-20mA Analog Output

Symptom	Cause	Action
4-20 output is missing, or zero current output	Incorrect wiring	Rewire per connector diagram
	Excessive load	Disconnect external equipment and test the output with VOM. If OK then reduce load resistance (maximum 500 Ω) or add <u>isolated</u> power to the current loop.
	Analog circuit board failure	Use the other output on the 308 card. If current is still 0 mA, replace card. If the VOM reads 4mA or greater, reprogram to use that output or replace the card. Part #60-4304-006

Table 4-5 Troubleshooting TIENet 308 4-20mA Analog Output

Symptom	Cause	Action
4-20 only reads 4mA	Wires on incorrect output (wired to output 2 instead of output 1)	Move connector to proper output
	Analog percent is not selected in the TIENet sensor configure options in Hardware setup	Reconfigure the 308 card.
	Improper parameter set for the output.	Verify/change the settings/range to the proper parameter.

Table 4-5 Troubleshooting TIENet 308 4-20mA Analog Output

Symptom	Cause	Action
4-20 reading incorrectly	Excessive load	Disconnect external equipment and test the output with VOM. If OK then reduce load resistance (maximum 500 Ω) or add <u>isolated</u> power to the current loop.
	Improper module/parameter set for the output	Verify/change the settings/range to the correct module/parameter.
	Connected to incorrect output; e.g., wired to output 2 instead of output 1	Move connector to proper output

Table 4-5 Troubleshooting TIENet 308 4-20mA Analog Output

Symptom	Cause	Action
Analog is not available under Outputs menu	TIENet 308 is not properly configured	Verify the TIENet configuration contains analog percent readings
Measurement error for analog current	No load applied to the output circuit, or open circuit wiring.	The output must have a load resistance (maximum 500 Ω). For verification, this can be accomplished by connecting the current meter leads to the terminals of the 308 card.

4.3.6 TIENet 310 USLS

Table 4-6 Troubleshooting TIENet 310 Ultrasonic Level Sensor

Symptom	Cause	Action
Invalid level, display has asterisk (*) by level reading	Not scanned	Perform a smart sensor scan
	Not able to achieve signal lock (misalignment, loose mounting, turbulence, foam, or debris in the water)	Adjust mounting or place over a solid surface.
	Level outside of the Blanking distances	Adjust min/max blanking distances

Table 4-6 Troubleshooting TIENet 310 Ultrasonic Level Sensor (Continued)

Symptom	Cause	Action
Invalid level, display has asterisk (*) by level reading (continued)	Not wired correctly	Check/repair wiring
	Open fuse	Replace fuse and rescan. Part #411-0212-70
	Failed sensor	Replace with known good sensor
No level reading on the display	Parameter not selected to be displayed on Home Display	Add the parameter to the Home Display.
Incorrect level reading	Level not adjusted properly	Readjust level

Table 4-6 Troubleshooting TIENet 310 Ultrasonic Level Sensor (Continued)

Symptom	Cause	Action
Incorrect level reading (continued)	Sensor misaligned	Realign sensor
	Objects in the path of the signal	Adjust min/max blanking distances and/or reposition sensor.
	Sensor exposed to direct sunlight	Install sunshade. (Refer to user manual.)

4.3.7 TIENet 330 Bubblers

Table 4-7 TIENet 330 Bubblers

Symptom	Cause	Action
No bubble out	Bubble line from Signature to primary device (weir/flume) damaged or blocked.	Clear blockage or replace bubble line. Perform a manual purge before resuming operation.
	Plugged orifice	Replace orifice/bubbler device
	Pump motor failure	Replace motor/bubbler device
	Damaged/pinched bubble line	Replace bubble line
	Blocked inlet air line	Remove the exterior desiccator and perform a manual purge. If the pump runs and has an output, repair/replace desiccator.
	Interior air line leaking/failure	Repair/replace damaged air lines

Table 4-7 TIENet 330 Bubbler (Continued)

Symptom	Cause	Action
Invalid level reading display; Asterisk (*) displayed next to reading.	Blocked bubble line	Remove bubble line to see if the bubbler will start reading. If yes, replace bubble line.
	Interior air line leaking/failure	Inspect all air lines and repair/replace where needed. Perform a manual purge.
Incorrect level reading	Bubble line starting to clog	Inspect all air lines and repair/replace where needed. Perform a manual purge.
	Incorrect level adjustment.	Measure and adjust to proper level
	Bubbler module failure	Replace the module

4.4 Service and Repair

Service tasks described in this manual may be performed on site by properly trained personnel. Other service and repairs must be performed at the factory. If your Teledyne Isco equipment requires repair, contact Teledyne Isco's Technical Service department.

Speaking with a Teledyne Isco Technical Service representative can often resolve the problem without the need to return the item. If the issue cannot be resolved by phone or email, you will receive a Return Authorization Number (RAN) and information on returning the equipment to the factory.

4.4.1 Contact Teledyne Isco

Teledyne Isco

Technical Service Dept.

P.O. Box 82531

Lincoln, NE 68501 USA

Phone:866 298-6174

402 464-0231

FAX:402 465-3085

E-mail:

IscoService@teledyne.com

